

## Breakfast Service







compact, versatile...mobile



### Performance Plus Service

The new **BURLODGE**<sup>®</sup> Breakfast Service carts meet the needs of today's ever changing healthcare market. Custom built and designed following recommendations from healthcare professionals, the ergonomic Breakfast Service cart allows either patients or residents a point of service menu choice. Delivered to the patient/residents room or dining area, the hospitality assistant personally assists each patient/resident with their menu choice.

### FEATURES

-  Increased patient satisfaction
-  Point of service menu choice
-  Increased personnel contact with patient
-  Paperless menu offers greater flexibility
-  Improved employee job satisfaction
-  Reduces the demand for late trays
-  Reduces food waste



### SPECIFICATIONS

Construction shall have all welded sub frame and chassis constructed of 304 # 4 stainless steel throughout. Sub frame shall be 12 gauge with 18 gauge side panels and supports.

Doors shall be accented green laminated melamine, with retaining opening/closing latches enclosed within.

Accented sided and front green laminated panels match door finish.

Laminated top provides efficient work surface, easy to clean and maintain.

Interior stainless steel tray supports accommodate 1/2 size **BURLODGE**<sup>®</sup> breakfast trays (Ref # 920.00.30). A second complement of tray supports accommodate cup and bowl racks 20" x 20".

Customized designed, highly polished stainless steel side rail acts as a push handle and supports condiment overshelf.

Overshelf designed to accommodate 1/3 size containers for various condiments (containers optional).

Bumper, wrap around non marking, heavy duty bumper, shall protect the complete cart at the base.

Casters, unit shall be mounted on 6" (160 mm) double bearing casters, 2 fixed and 2 swivel c/w brakes. Special caster configuration allows cart to turn easily through 360 degrees in a small turning circle.

Casters, unit shall be mounted on 6" (160 mm) double bearing casters, 2 fixed and 2 swivel c/w brakes. Special caster configuration allows cart to turn easily through 360 degrees in a small turning circle.

Casters, unit shall be mounted on 6" (160 mm) double bearing casters, 2 fixed and 2 swivel c/w brakes. Special caster configuration allows cart to turn easily through 360 degrees in a small turning circle.

Casters, unit shall be mounted on 6" (160 mm) double bearing casters, 2 fixed and 2 swivel c/w brakes. Special caster configuration allows cart to turn easily through 360 degrees in a small turning circle.

Casters, unit shall be mounted on 6" (160 mm) double bearing casters, 2 fixed and 2 swivel c/w brakes. Special caster configuration allows cart to turn easily through 360 degrees in a small turning circle.

Casters, unit shall be mounted on 6" (160 mm) double bearing casters, 2 fixed and 2 swivel c/w brakes. Special caster configuration allows cart to turn easily through 360 degrees in a small turning circle.

Casters, unit shall be mounted on 6" (160 mm) double bearing casters, 2 fixed and 2 swivel c/w brakes. Special caster configuration allows cart to turn easily through 360 degrees in a small turning circle.

Casters, unit shall be mounted on 6" (160 mm) double bearing casters, 2 fixed and 2 swivel c/w brakes. Special caster configuration allows cart to turn easily through 360 degrees in a small turning circle.

Casters, unit shall be mounted on 6" (160 mm) double bearing casters, 2 fixed and 2 swivel c/w brakes. Special caster configuration allows cart to turn easily through 360 degrees in a small turning circle.

Casters, unit shall be mounted on 6" (160 mm) double bearing casters, 2 fixed and 2 swivel c/w brakes. Special caster configuration allows cart to turn easily through 360 degrees in a small turning circle.

Casters, unit shall be mounted on 6" (160 mm) double bearing casters, 2 fixed and 2 swivel c/w brakes. Special caster configuration allows cart to turn easily through 360 degrees in a small turning circle.



Casters, unit shall be mounted on 6" (160 mm) double bearing casters, 2 fixed and 2 swivel c/w brakes. Special caster configuration allows cart to turn easily through 360 degrees in a small turning circle.

Casters, unit shall be mounted on 6" (160 mm) double bearing casters, 2 fixed and 2 swivel c/w brakes. Special caster configuration allows cart to turn easily through 360 degrees in a small turning circle.

Casters, unit shall be mounted on 6" (160 mm) double bearing casters, 2 fixed and 2 swivel c/w brakes. Special caster configuration allows cart to turn easily through 360 degrees in a small turning circle.

Casters, unit shall be mounted on 6" (160 mm) double bearing casters, 2 fixed and 2 swivel c/w brakes. Special caster configuration allows cart to turn easily through 360 degrees in a small turning circle.

### OPTIONAL EQUIPMENT

-  Drop down front tray rail  
Ref # M21.004
-  Lateral side mounted shelf  
Ref # M20.017
-  1/2 size **BURLODGE**<sup>®</sup> Breakfast trays Ref # 920.00.30

### CAPACITY

1/2 size trays 16 - 2 per slide  
20 x 20 dish baskets - 6

# Breakfast Service Cart

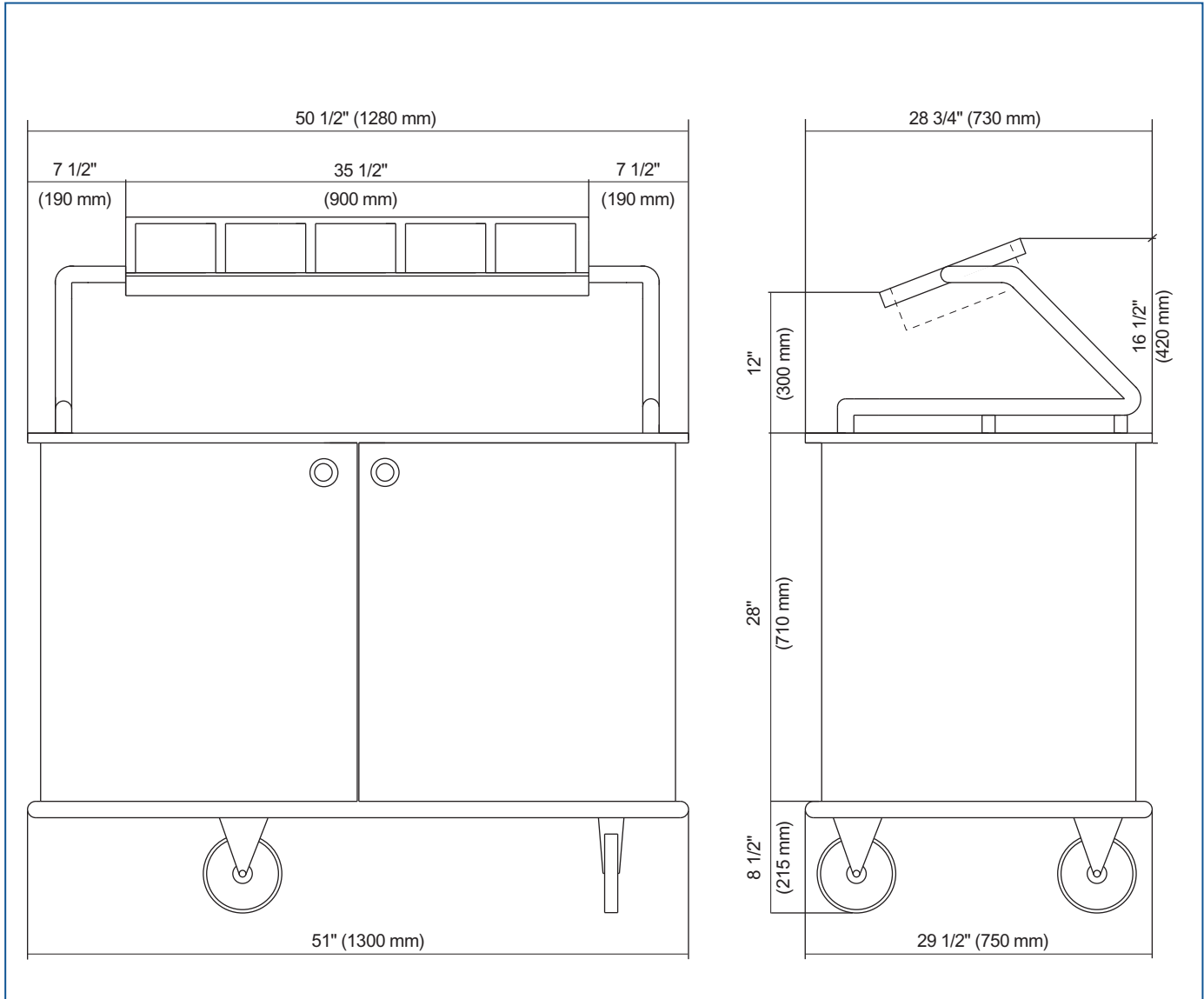

| MODEL NO.   | DESCRIPTION                       | DIMENSIONS        |                  |                  | CAPACITY          |
|-------------|-----------------------------------|-------------------|------------------|------------------|-------------------|
|             |                                   | LENGTH            | DEPTH            | HEIGHT           |                   |
| BOA.000     | Breakfast Cart                    | 50 1/2" (1280 mm) | 28 3/4" (730 mm) | 36 1/2" (925 mm) | -                 |
| 270.094.007 | Overshelf                         | 35 1/2" (900 mm)  | 13 1/2" (345 mm) | 16 1/2" (420 mm) | 5 x 1/3 size pans |
| BOA.011     | Tray slides for breakfast trays   | 12 3/4" (325 mm)  | 23 1/4" (590 mm) | 3 1/8" (80 mm)   | 8 level x 2 (16)  |
| BOA.015     | Tray slides for 20" x 20" baskets | 20" (505 mm)      | 23 1/4" (590 mm) | 4 3/8" (110 mm)  | 6 x (20" x 20")   |

See options on front page for tray rail, side shelf and breakfast tray model numbers.

|  |  |  |   |
|--|--|--|---|
| <p><b>BURLODGE CANADA LTD</b><br/>         10, EDVAC DRIVE<br/>         BRAMPTON<br/>         ONTARIO L6S 5P2<br/>         CANADA<br/>         TEL. 905 790.1881<br/>         TOLL FREE: 1 888 609.5552<br/>         FAX 905 790.1883<br/>         E-mail: info@burlodgeca.com<br/>         www.burlodgecanada.com</p> | <p><b>BURLODGE CANADA LTÉE</b><br/>         5995 boul. GOUIN OUEST<br/>         BUREAU - 305<br/>         MONTRÉAL, QUÉBEC H4J 2P8<br/>         CANADA<br/>         TEL. 514 339.5552<br/>         TOLL FREE: 1 888 609.5552<br/>         FAX. 514 339.2555<br/>         E-mail: infoquebec@burlodgeca.com<br/>         www.burlodgecanada.com</p> | <p><b>BURLODGE USA Inc.</b><br/>         P.O. BOX 4088<br/>         3760 INDUSTRIAL DRIVE<br/>         WINSTON - SALEM<br/>         NORTH CAROLINA 27115 - USA<br/>         TEL. 336 776 1010<br/>         TOLL FREE: 1 877-REThERM<br/>         FAX 336 776 1090<br/>         E-mail: info@burlodgeusa.com<br/>         www.burlodgeusa.com</p> | <p><b>ASSOCIATED COMPANIES</b><br/>         BURLODGE GREAT BRITAIN<br/>         BURLODGE ITALY<br/>         BURLODGE FRANCE<br/>         BURLODGE HOLLAND<br/>         BURLODGE BELGIUM</p> |
|--|--|--|---|